



Fagor Automation S. Coop.

20i-M / 30i-M 20i-M B / 30i-M B

Installation/Operation Manual

Manual code: 14460053
Manual version: 0703
Software version: 4.xx



INDEX

1	DRO description	3
1.1	Front panel	3
1.2	Turning the unit on and off	4
2	DRO operation	5
2.1	Display modes	5
2.2	Incremental, absolute and with respect to Machine Reference Zero	6
2.2.1	Example	7
2.2.1.1	Absolute mode	7
2.2.1.2	Incremental mode	8
2.3	Machine Reference selection and search	9
2.3.1	Home search sequence:	9
2.4	Operating with tools	10
2.4.1	Entering tool dimensions	10
2.4.2	Tool dimension compensation while machining	10
2.4.3	Datum point (part zero) to work with tool compensation	10
2.5	Special operations	11
2.5.1	Scaling factor	11
2.5.2	Part centering	12
2.6	Examples of how to operate with tool compensation	12
2.6.1	Inside pocket	12
2.6.2	Outside pocket	13
2.7	Access to special modes	14
2.7.1	Linear and bolt-hole drilling	15
2.7.1.1	Work plane selection:	15
2.7.1.2	Bolt-hole drilling	15
2.7.1.3	Execution of bolt-hole drilling	16
2.7.1.4	Linear drilling	17
2.7.2	Coordinate freeze (HOLD)	17
2.7.3	Calculator	18
2.7.3.1	Operating with the calculator	18
2.7.3.2	Recall and Reset modes	19
2.7.4	Part angle measuring	20
2.7.5	Corner rounding	21
3	DRO installation	22
3.1	Installation of the built-in model	22
3.2	Rear panel	23
3.3	General technical characteristics	24
3.4	Connections	24
3.4.1	Connection of the feedback systems	24
3.5	Easy setup	25
3.5.1	Accessing the "Easy Setup" mode	25
3.5.2	Operating mode	25
3.5.3	Power and machine connection	26
3.6	Installation parameters	26
3.7	Parameters to configure axis position reading and display	28
4	Appendix	35
4.1	UL seal	35
4.2	CE seal	35
4.2.1	Declaration of conformity	35
4.2.2	Safety conditions	36
4.2.3	Warranty terms	38
4.2.4	Material returning terms	38
4.3	Error codes	39
4.4	Maintenance	40

1 DRO description

1.1 Front panel

Each axis display has eight 14.1mm high LEDs and another one for the minus sign (-).

Description of LED's and keys:



ABS It stays on when operating in absolute mode and off when in incremental mode. To access it or quit it, press this key.



Φ It stays on when operating in diameter mode. In this mode, the DRO displays twice the actual axis movement. To access it or quit it, use this key if allowed by installation parameter PAR04.



INCH It stays on when working in inches and off when doing it in millimeters. To access it or quit it, press this key.



This key toggles the display format for the rotary axis [PAR00(4)=1] between decimal degrees and Degrees.Minutes.Seconds.



To get into and out of home search mode.

TOOL

It stays on when operating in tool radius compensation mode.



Activate tool radius compensation.



Cancel tool radius compensation.



Select the current reference.



To access the special functions (bolt-hole and linear drilling, hold, calculator, part angle, corner rounding).



To select the axis or preset it with a certain value.

To zero the axis when the "quick zeroing" mode has been activated (see PAR11 in the installation manual).



To turn the display off while keeping track of the axes position at all times.



To cancel or abort an operation already initiated.



To validate a preset value or another operation.

Beginning of preset when the "quick zeroing" mode has been activated (see PAR11 in the installation manual).



Editing the tool diameter



To change the sign of the entered value or change from fine to coarse resolution and vice versa.

1.2 Turning the unit on and off

It turns on automatically when applying voltage or after pressing the on/off key.

It shows **Fagor dro** or the corresponding error code. See the error table and PAR11 for more options.



Turns the DRO on or off.

Precautions



Before disconnecting this unit from mains, press this key so it saves the current position.



If the unit is turned off or there is a power outage, the DRO will try to save the current position. If it does not have enough time to save all the data, it will display ERROR 2 when turned back on.

2.1 Display modes

MM / INCH conversion



To display the position of the axes either in millimeters or inches by pressing this key depending on whether the INCH led is off or on respectively.

Fine / coarse resolution



To turn off the last decimal digit (coarse resolution) for cases in which fine resolution is excessive, simply by pressing this key.

Number of decimals



This keystroke sequence accesses parameter PAR53. The first digit corresponds to the number of decimals to be displayed in mm and the second digit in inches.

Decimal degrees / Degrees.Minutes.Seconds



This key toggles the display format for the rotary axis [PAR00(4)=1] between decimal degrees and Degrees.Minutes.Seconds.

Radius / Diameter



When these models are used for measuring radii or diameters, one can display twice the real displacement of the axis (diameter) by pressing this key. The Φ led will turn on or off to indicate the double or actual reading respectively.

Notes: - This works in this way if bit 2 of installation parameter PAR04 (radius/diameter) of the axis has been preset as "1" (commutated).

Hysteresis or minimum position value

When carrying out certain operations such as drilling hard material, EDM, etc. the position display may fluctuate annoyingly.



In these cases, the operator can eliminate this oscillation by selecting the "hysteresis" mode or the "minimum coordinate" mode just by pressing this keystroke sequence to toggle from one mode to the other.

Note: To have this option available, installation parameters PAR20 and PAR25 must be set accordingly.

Part references (datum points)

There are 20 references or datum points that may be set for the part when using absolute coordinates. The possible reference points (datum points) are from 0 to 19. The 20i-M model shows the active reference on the display at all times, whereas the 30i-M model only shows it when it is selected, after pressing the reference key.



Selects the current reference. It will show the text "Select ref".

[Ref number]



Key in the desired reference number and press [ENTER].

2.2 Incremental, absolute and with respect to Machine Reference Zero

A coordinate DRO displays the present coordinate of one or several axes.

Coordinate means the distance from one point or position with respect with another chosen as reference.

These DROs can display the position of the axes in incremental or absolute mode or referring to home.

The next figure shows the different position display modes:

- In **Home mode**, it displays the distance from the current position of the axis to the home point chosen in the feedback system (linear or encoder).



Press this sequence to access the **Home Search** mode.

- (ABS) • In **Absolute** (ABS), when the ABS led is on, it displays the distance from the present position of the axis to part zero (D).

- (I) • In **Incremental**, when the ABS and "home" LEDs are off the distance from the present position of the axis to the previous position is displayed.



Toggles between the ABS and incremental modes.



It could occur that the installation parameter PAR11(1) has been set to "0" for this key to independently affect each axis so that one axis can display its position in incremental mode while the other does this in absolute. In this case, to change the display mode for a particular axis, press one of these two sequences.

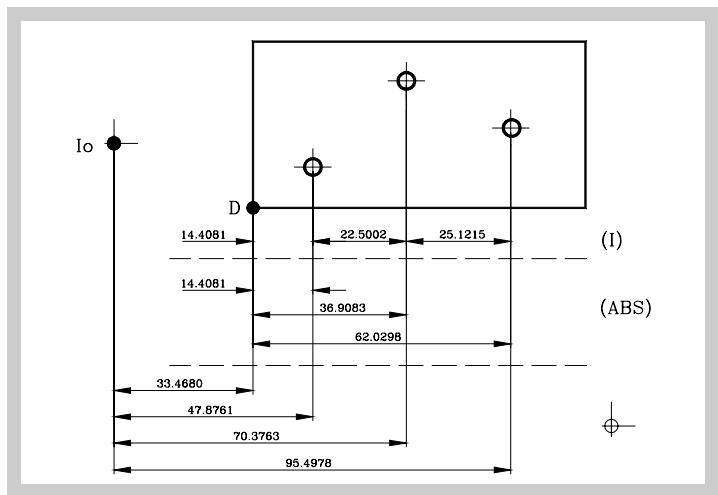

2.2.1 Example

We will drill the holes of the following part as moving examples in incremental and absolute modes.

First, set the datum point on the part to be machined as described in the section Datum point (part zero) to work with tool compensation

The axis must be positioned without tool compensation (canceled) because the hole coordinates are referred to the center and no tool radius compensation is needed.

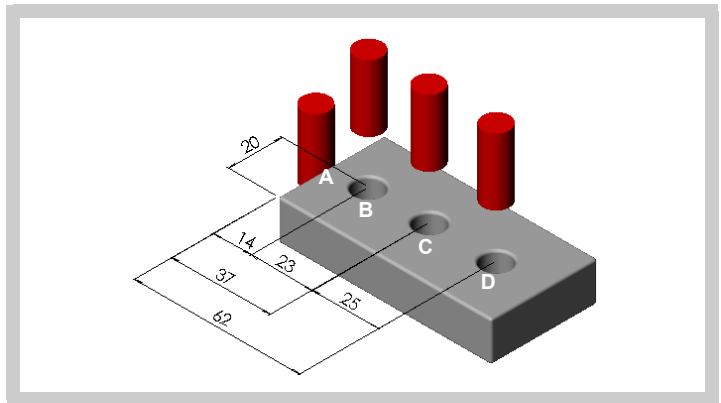

2.2.1.1 Absolute mode

ABS  Set the dro in absolute mode

(B) [14.000] Move the axis until the display reads [14.000] (B position) and drill the hole.

(C) [37.000] Move the axis until the display reads [37.000] (C position) and drill the hole.

(D) [62.000] Move the axis until the display reads [62.000] (D position) and drill the hole.

The displayed position value is always referred to the preset part zero (datum).

2.2.1.2 Incremental mode

“**ABS**” off Set the dro in incremental mode. ABS LED off

First method: Presetting incremental zero after each drill.

Starting at point A.

(B) [14,000] Move the axis until the display reads [14,000] (B position) and drill the hole.



Set the X axis to zero. See note.

(C) [23,000] Move the axis until the display reads [23,000] (C position) and drill the hole.



Sets the X axis to zero. See note.

(D) [25,000] Move the axis until the display reads [25,000] (D position) and drill the hole.

Note: If installation parameter PAR11=1, just press the axis key, ([X]) in this case, to zero the axis.

Second method: Presetting the relative distance with respect to the next hole.

Starting at point A



-14  Preset the relative distance to the next hole. See note.

(B) [0.000] Move the axis until the display reads [0.000] (B position) and drill the hole.



-23  Preset the relative distance to the next hole. See note.

(C) 0.000 Move the axis until the display reads [0.000] (C position) and drill the hole.



-25  Preset the relative distance to the next hole. See note.

(D) [0.000] Move the axis until the display reads [0.000] (D position) and drill the hole.

Notes: If installation parameter PAR11=1, the presetting sequence is: **[ENTER]** [axis] [value] **[ENTER]**.

Switching over to **[ABS]** mode, displays the distance to part zero (datum).

The **calculator** function can also be used to preset an axis with the result of the calculation. See section 2.7.3 Calculator.

2.3 Machine Reference selection and search

Although it is not absolutely necessary, it is recommended to use the reference marks (lo) of the feedback system in order to set a machine zero point.

This allows the user to reference the machine axes and restore the work coordinates after having turned the dro off, moved the machine while the dro was off, for safety or for any other reason.

Fagor linear encoders have reference marks every 50 mm all along its length.

In order to use these marks properly, choose an area on the axis, for example in the middle of the measuring length or at one end. Approach this area and carry out the home search. Once the reference mark has been found, mark this area with a marker or sticker in order to carry out the home search in the same area in later occasions and make sure that you are using the same machine zero point (home).

Fagor also offers encoders with distance-coded reference marks every 20, 40 or 100 mm. When using these distance-coded reference marks, there is no need to move to the 0 position to find the references, simply move a distance equal to the gap between marks (20, 40 or 100 mm depending on the linear encoder)

When using an absolute encoder, there is no need to search for the reference marks (home).

The dro stores in its internal memory work coordinates such as machine zero, absolute and incremental.

2.3.1 Home search sequence:

For encoders with regular reference marks, move the axis to the home area.



Access or exit the home search mode.

The axis displays blink showing " r " if the axis has not been homed or " r on" if it has been homed.



Select the axis to be referenced (homed)

The selected axis blinks until a reference mark is detected. The reference signal presets the axis display automatically with the value of PAR10, 0.000 mm by default.



If the encoder does not have a reference mark, move the axis to the desired position and press this key.

2.4 Operating with tools

It is possible to define a tool and later compensate for its dimensions while machining.

2.4.1 Entering tool dimensions



The Y axis blinks waiting for the tool value to be entered.

20i-M.- It requests the tool diameter.

30i-M.- It requests the diameter on the Y axis and the length on the Z axis.



Enter this value pressing this keystroke sequence.

Note: Since only the diameter of a tool may be stored, when changing a tool, its dimensions must be entered again.

2.4.2 Tool dimension compensation while machining

To properly machine the part, the tool diameter must be compensated depending on the machining direction.

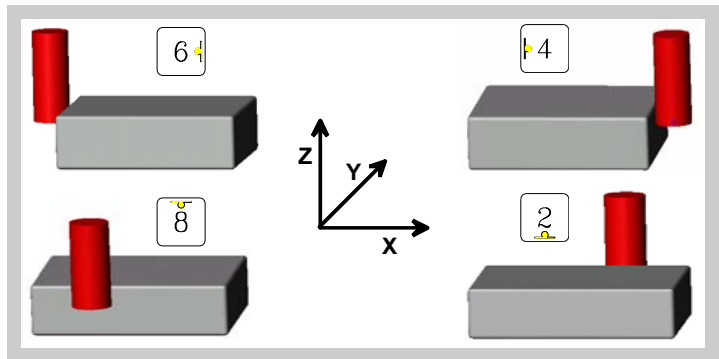

Tool This led turns on when activating any of the compensations.



Cancels tool compensation and turns the Tool led off.

2.4.3 Datum point (part zero) to work with tool compensation



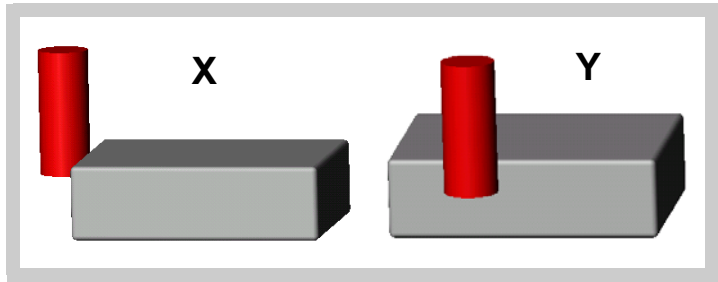

Set the dro in absolute mode.

Move the tool and touch the side of the part, activate the corresponding compensation and set the axis to zero.





In the example of the figure, the sequence would be:

 For the X axis, move the tool and touch it on the left side and press this key.

  To preset this side to "0". See note.

 For the Y axis, move the tool and touch it on the lower side and press this key.

  To preset this side to "0". See note.

Notes: If installation parameter PAR11=1, just press the axis key, [X] [Y] or [Z], to zero it.

The tool diameter value must be previous entered in order to set the datum (zero) point correctly.

2.5 Special operations

2.5.1 Scaling factor

It is possible to apply a scaling factor within ± 9.999 for mold making applications:

   [factor] 

The DRO will then show the axis position resulting from multiplying its real position by the 'value' of the scaling factor.

2.5.2 Part centering

Note: This feature is available when none of the axes have installation parameter PAR04(2)=1 (radius/diameter commutable).

Part centering can be done as follows:



- Set the dro in absolute mode.
- Touch one side of the part with the tool.



- Set the reading to zero pressing for an axis [CLEAR] [X] for one axis or [CLEAR] [Y] for the other one.



- Take the tool to the other side of the part and touch this with it.



- Press the sequence [1/2] [X] for one axis or [1/2] [Y] for the other. The DRO will display half of the distance covered by the tool.



- Retract the axes until the displays read 0.0000, the tool can be placed exactly at the center of the part.

2.6 Examples of how to operate with tool compensation



The following illustration displays the typical application of tool compensation to make both an inside and outside pocket.



Tool compensation is applied by pressing either [6] , [4] , [8] or [2] and canceled by pressing [5] .

After presetting the tool diameter, as was described in the previous section, it is advisable to know how to apply the compensation before making said movement.

2.6.1 Inside pocket

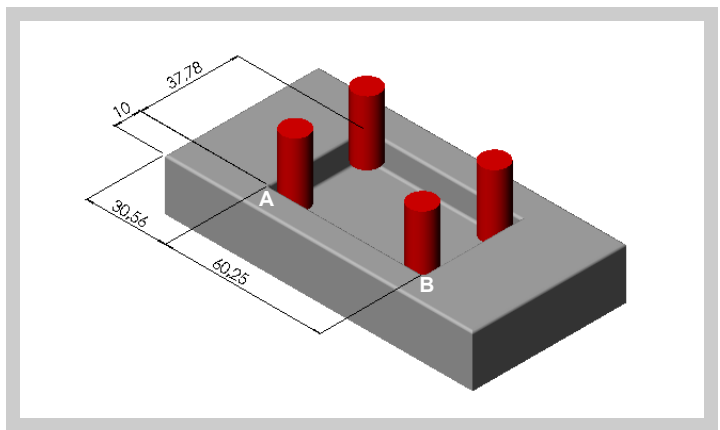



- Go into incremental. ABS LED OFF.

- Preset the part zero or datum point (see section "Datum point (part zero) to work with tool compensation" page 10)

Go to point A. For that:



[-30.56]



- Press these keystroke sequences.



[-10.00]



- Compensate for the tool.

X 0.000 Y 0.000 - Move both axes until the displays read X 0.000 and Y 0.000.

Go to point B. For that:



[-60.25]



- Press these keystroke sequences.



[-0.000]



- Compensate for the tool.

X 0.000 Y 0.000 - Move X axis until the displays read X 0.000 and Y 0.000.

And so on for the remaining points of the figure using the icon keys shown.

2.6.2 Outside pocket

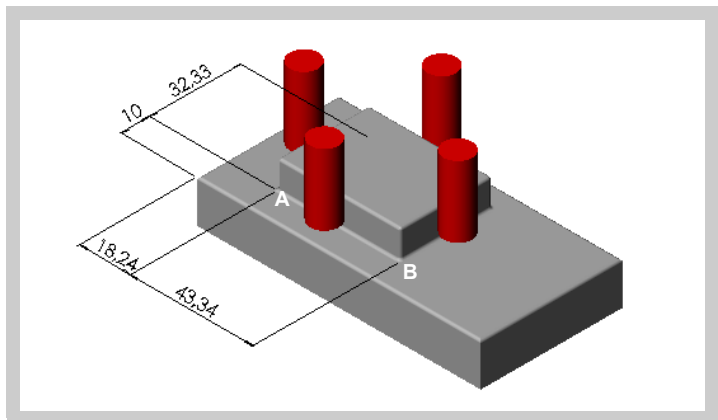



- Go into incremental. ABS LED OFF.

- Preset the part zero or datum point (see section "Datum point (part zero) to work with tool compensation" page 10)

Go to point A. For that:



[-18.24]



- Press these keystroke sequences.



[-10.00]



- Compensate for the tool.

X 0.000 Y 0.000 - Move both axes until the displays read X 0.000 and Y 0.000.

Go to point B. For that:



[-43.340]



- Press these keystroke sequences.



[-0.000]



- Compensate for the tool.

X 0.000 Y 0.000 - Move X axis until the displays read X 0.000 and Y 0.000.

And so on for the remaining points of the figure using the icon key shown.

2.7 Access to special modes



Pressing **[F]** accesses the "special functions" menu.

Pressing this key repeatedly displays the various available options.



Pressing **[ENTER]** assumes the selected option.

A function may be directly accessed by pressing **[F]** and then the **function number**:

Function number 1= bolt-hole drilling, 2 = linear drilling, 3 = hold, 4 = calculator, 5 = part angle, 6 = corner rounding.

For example:



[F] [1] to access **BOLT-HOLE DRILLING**.



[F] [4] to directly access the **CALCULATOR** mode.

2.7.1 Linear and bolt-hole drilling

For 3-axis DRO's (30i-M) it is possible to select the work plane for linear or bolt-hole drilling. The possible work planes are: (XY, XZ, YZ).

2.7.1.1 Work plane selection:

Note: To enable this function.

Selection sequence if PAR11 bit 3 = 1:



After pressing this key.

Select the two axes that form the plane by pressing their keys [X], [Y] or [Z].



Then press this key.

2.7.1.2 Bolt-hole drilling

It allows up to 99 holes to be drilled in a bolt-hole pattern without having to calculate the coordinates (X Y) of each hole, by simply keying in some basic data.



To access the bolt-hole drilling mode directly

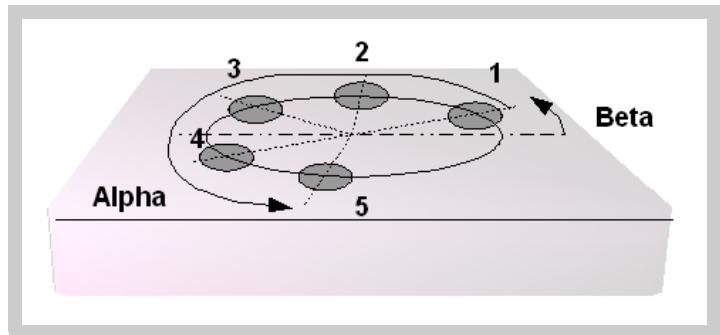

Example:

CENTER Coordinate of the center of the bolt-hole (X = 37.899, and = 30.467)

RADIUS RADIUS of the bolt-hole (23.918)

HOLES N Nr. of HOLES to be drilled (5)

ALPHA α Total angle between the first and last hole (240°).

DELTA Δ angular distance between holes (60°). Only requested when HOLES = 0.

bEtA β position of the first hole (15°).

To make this part:

Select the work plane selection. See section **2.7.1.1 Work plane selection:**.

Entering data:



- Position the tool at the bolt-hole center (X = 37.899, Y = 30.467) and press this key.

RADIUS[23.918]



- Enter the radius.

HOLES

5



- Enter the number of holes.

ALPHA [240]



- Enter the angular distance between the first and last holes.

dELTA [60]



When entering "0" holes, enter the angular distance between holes.

bETA [15]



- Enter the angle of the first hole.



If a wrong value were keyed in before pressing [ENTER], press [CLEAR] and key in the right value.

2.7.1.3 Execution of bolt-hole drilling

After entering this data, the DRO displays the text "HOLE 01" in the display "X" and turns the "Y" off.



- After pressing this key to---

X -23,105 Y -6,190 - ... show the position of the first hole:

X 0.000 Y 0.000 - Move the axes until the displays read X 0.000 and Y 0.000



- Press this key

HOLE 02 - It displays this text.



- Press this key again to---

X 16.915 Y -16.915 ... show the position of the second hole.



- Press this key to display the current position with respect to the previous hole.

X 0.000 Y 0.000 - Move the axes until the displays read X 0.000 and Y 0.000

And so on until all the holes are completed (all 5 in the example).

2.7.1.4 Linear drilling

This feature guides the user in the linear drilling operation.



To access the "linear drilling" mode directly

Requested data:

- DiST:** Straight distance (gap) between two consecutive holes.
- HOLES:** Number of holes to be drilled (3 in the figure).
- ALPHA:** Angle in the trigonometric direction.

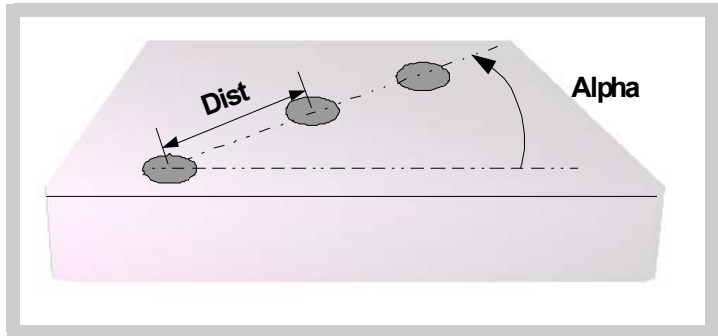

2.7.2 Coordinate freeze (HOLD).

It enables "freezing" the display of the counter whilst inside it goes on reading the real position of the axis. This comes about when it is necessary to change the tool and preset the dimension of the new one.

Example: To change a tool at any known point of the part:

- Touch the part with the tool.

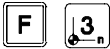

- Go into **HOLD** mode. The reading for that axis freezes with the current value.



- Select the axis.

- Remove the tool to be replaced and insert the new one.

- Approach the new tool to the "freezing" point and touch the part at that point.



- Press this key. The reading "unfreezes" and starts counting from the previously "frozen" value.



If this key is pressed instead, the DRO will assume half the distance traveled since [**HOLD**] was pressed. This is possible when "freezing" only one axis.

2.7.3 Calculator

This feature may be used to carry out mathematical and trigonometric operations as well as preset the desired axis with the result of the calculation or use the coordinates of the axes to carry out math operations.



To access the calculator mode



To quit the calculator mode.

2.7.3.1 Operating with the calculator.



Enters the first operand in the X axis display



Enters the second operand in the Y axis display.



Toggles between the various operations:

Basic operations

Display	Meaning	Operation
ad	Add	Result = $X + Y$
su	Subtract	Result = $X - Y$
nu	Multiply	Result = $X * Y$
di	Divide	Result = X / Y



Toggles between the various trigonometric operations

Trigonometric operations

Display	Meaning	Operation
Sin	Sine	Result = $\sin X$
Cos	Cosine	Result = $\cos X$
Tan	Tangent	Result = $\tan X$



It carries out the operation and leaves the result on the X axis display.

2.7.3.2 Recall and Reset modes



Toggles between the recall and Preset modes.

RECALL mode The recall mode lets enter the current axis position into the calculator.



Enters the current position of the selected axis into the calculator.

PRESET mode The preset mode lets preset the desired axis with the result of an operation.



Presets the selected axis with the result of the calculation.

Example Calculate [Y position] / 5 and preset the Y axis with the result.

Display	keys	Operation	Display
X = 25 Y= 10 Z = 16	4	Goes into calculator mode	X = 0 Y= 0 Z = Ad
X = 0 Y= 0 Z = Ad		Goes into RECALL mode and enters the current position in the Y axis.	X = 10 Y= 0 Z = Ad
X = 10 Y= 0 Z = Ad	5	Presets the divisor (5)	X = 10 Y= 5 Z = Ad
X = 10 Y= 0 Z = Ad	3 times	Selects the divide operation	X = 10 Y= 5 Z = di
X = 10 Y= 5 Z = di		Result in the X display (2)	X = 2 Y= Z = di
X = 2 Y= Z = di		Goes into Preset mode	X = 2 Y= Preset Z =
X = 2 Y= Preset Z =		Presets the Y axis with the result of the calculation.	X = 25 Y= 2 Z = di
X = 25 Y= 2 Z = di		Quits the calculator mode.	X = 25 Y= 2 Z = 16



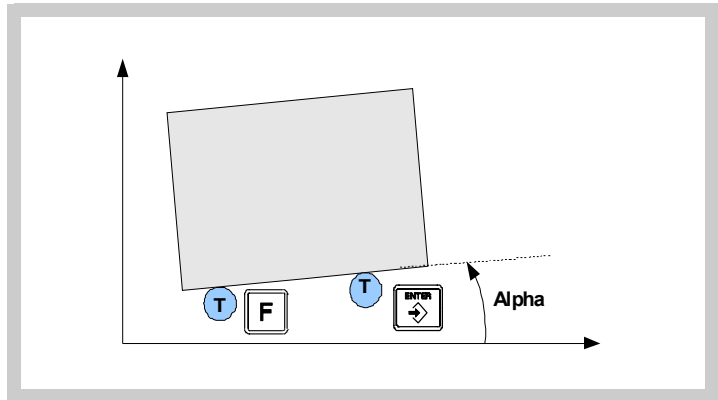

2.7.4 Part angle measuring

To control the part orientation angle to properly machine the part.

It calculates the angle between a particular side of the part and the horizontal (X axis) by simply touching two points on it.



To do this, follow this procedure:

- Move the tool until it touches the part at any point.
 -   - Access the angle calculation mode.
 - Touch the part with the tool at any other point.
 -   - Press **[ENTER]** so the DRO calculates the angle or **[C]** to cancel the operation.
- The "X" axis display will show the angle in ten-thousandths of a degree (0.0001°) and the "Z" axis display will do so in degrees, minutes and seconds.
- Press any key to return to the regular display mode.

2.7.5 Corner rounding

This features guides the user in the corner rounding process in the selected plane.

The DRO guides the machining running several passes until obtaining the desired part. The number of passes depends on the tool radius being used. The smaller the tool diameter, the more passes will be required for a better part finish.



Go into corner rounding mode

Requested data:

Starting position: The current position is assumed as the starting point for the machining operation.

Tool dimensions: If no tool has been defined, diameter = 0, it will request a diameter value.

Work plane and final position: select the axes that define the desired plane XY, YZ or XZ and enter the final position.

Note: The value of the final position must be incremental or absolute according to the selected work mode, incremental (ABS led off) or absolute (ABS led on).

Rounding radius: enter the rounding radius. A negative value($r-$) means concave and a positive value ($r+$) convex.

Quadrant: Trigonometric quadrant number.

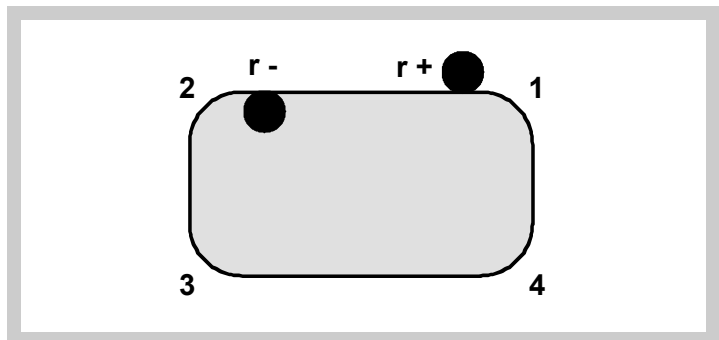

3 DRO installation

3.1 Installation of the built-in model

Dimensions of the enclosure hole for inserting the DRO

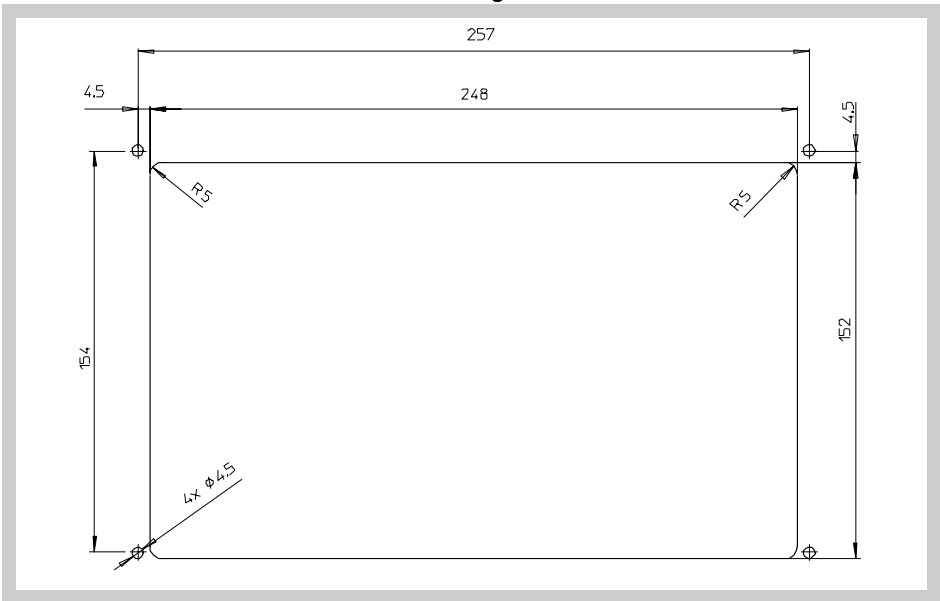

Built-in DRO insertion

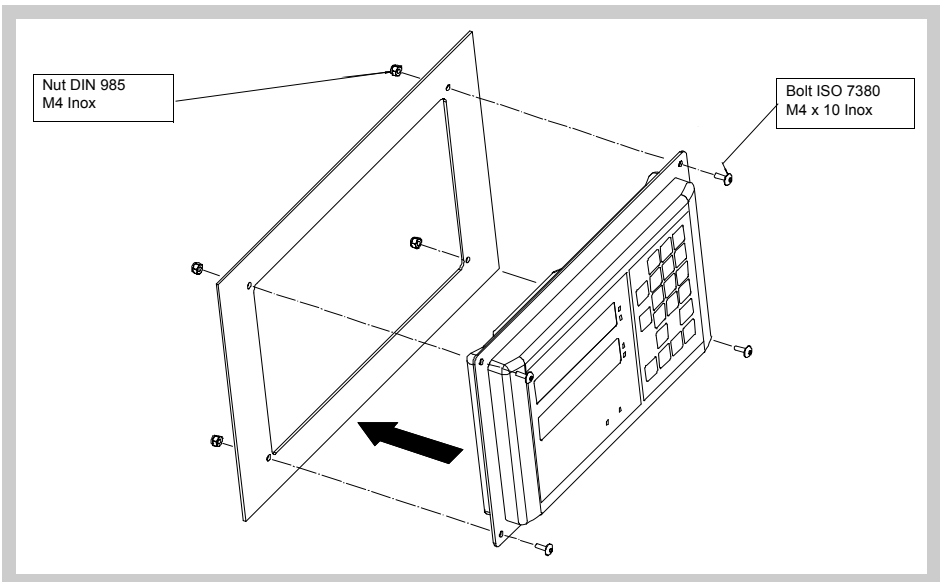

3.2 Rear panel

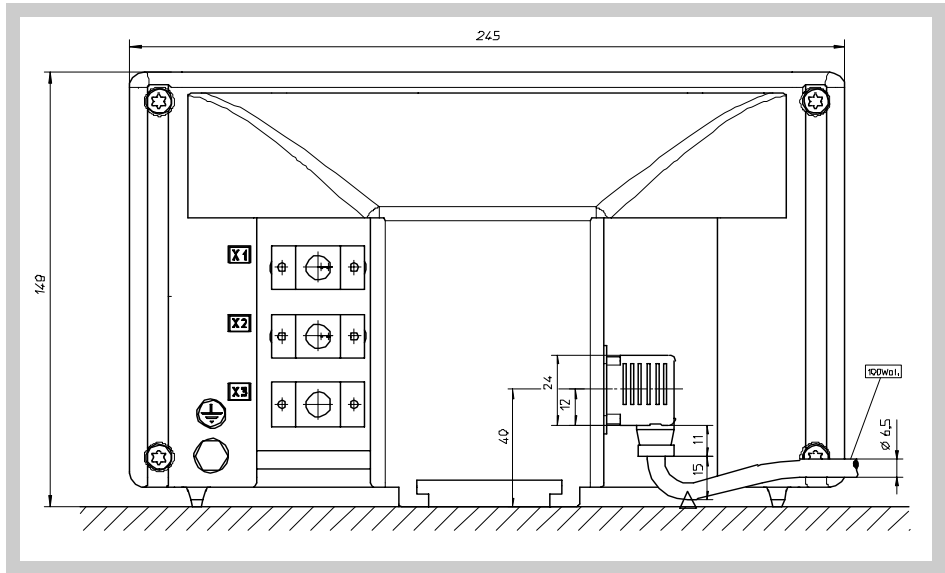

On the back of the unit the following items may be found:

1. Three-prong power connector for AC and ground connection.
2. M6 mm terminal for general machine ground connection.
3. Mounting bracket

Some of the following connectors might not be available depending on specific models:

- X1.- SUB-D HD type 15-pin female connector for 1st axis feedback device.
- X2.- SUB-D HD type 15-pin female connector for 2nd axis feedback device.
- X3.- SUB-D HD type 15-pin female connector for the third axis feedback device. Only available at the 30i-M model.

UL seal



In order to comply with UL standards, this unit must be connected in the final application using a listed detachable cord set (BLEZ) with a molded three-prong plug and a suitable fitting to be connected to the equipment, rated minimum 300 V AC. The cord type shall be SO, SJO or STO. Suitable Strain Relief means must be provided in the cord set to assure the connection of the plug and the fitting.

CE seal (see "CE seal" page 35)

WARNING



Do not handle the connectors while the unit is under power.

Before handling the connectors (mains, feedback, etc.) make sure that the unit is not under power.

It is NOT enough to turn the display off by using the [on/off] key at the keyboard

3.3 General technical characteristics

- Universal Power Supply between 100V AC and 240V AC $\pm 10\%$ at Mains frequency between 45 Hz and 400 Hz. Between 120Vdc and 300 Vdc
- It withstands power outages of up to 20 milliseconds.
- 10-year memory backup of installation parameters when the unit is off.
- The operating temperature inside the DRO enclosure must be between 5° C and 45° C (41°F and 113°F).
- The storage temperature inside the DRO enclosure must be -25° C and +70° C (-13° F and 158° F).
- Maximum relative humidity: 95% non condensing at 45°C (113°F).
- Front Panel Sealing: IP54 (DIN 40050), Rear panel: IP4X (DIN40050) except for built-in models in which case is: IP20.

3.4 Connections

3.4.1 Connection of the feedback systems

The feedback systems (linear or rotary encoders) are connected via SUB-D HD type 15-pin female connectors: X1 through X3. The latter (for the 2nd axis) is not available at the 10i model.

Characteristics of feedback inputs: X1, X2 and X3:

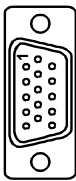

- Power consumption: 250 mA at the +5V input.
- Admits square-wave signal (TTL).
- Maximum frequency: 250 KHz, minimum gap between flanks: 950 nsec.
- Phase shift: 90° $\pm 20^\circ$, hysteresis: 0.25 V, Vmax: 7V, maximum input current: 3mA
- High threshold (logic state 1) $2.4V < V_{IH} < 5V$
- Low threshold (logic state 0) $0.0V < V_{IL} < 0.55V$

Feedback connection. Connectors X1, X2 and X3

Pin	Signal	Function
1	A	Input for feedback signals
2	/A	
3	B	
4	/B	
5	I0	
6	/I0	
7	Alarm	
8	/Alarm*	
9	+5V	Power supply to feedback devices
10	Not connected	
11	0V	Power supply to feedback devices
12, 13, 14	Not connected	
15	Chassis	Shield

3.5 Easy setup

The "Easy Setup" may be used to set up the feedback of the DRO and to verify that the installation is correct and no feedback pulses are missed.

It sets up the encoder resolution and the kind of reference marks being used as well as the positive counting (reading) direction.

3.5.1 Accessing the "Easy Setup" mode



Press **[CLEAR]** **[OFF]**

CODE: 555 And, instead of entering the parameters accessing code, key in: **555**

The axes displays will show "**Setup**" meaning that the feedback is not set up yet.

3.5.2 Operating mode.

- Move the axis to the desired origin or zero point and press the axis key.

The display shows "**START**".

- Move the axis in the direction that you wish to define as positive all the way to the end of the travel so the DRO can read as many reference marks as possible.



- Press **[ENTER]** to finish. The moving direction used will be assumed as the positive direction.

The axis status will then switch to one of the following:

Ready Feedback configured properly.

It has set PAR00 (feedback reading direction), PAR01 (resolution), PAR03 (multiplying factor) and PAR14 (type of reference mark, I0)

Repeat Wrong feedback setup, the process should be repeated.

Error Error in the feedback system.

Note: If the feedback device is a steel tape type linear encoder, press **[F]** before pressing **[ENTER]** so it is properly detected.

3.5.3 Power and machine connection

Always mount it vertically so its keyboard is within operator's reach and its digits are easily visible (at operator's eye level).

Do not connect or disconnect the DRO connectors while it is under power.

Connect all metallic parts to a common point on the machine tool and it to the general ground point. Use cables of enough gage (no thinner than 8 mm²) for this connection.

3.6 Installation parameters

These DROs have a number of installation parameters to configure it for a particular application.

The way these parameters are displayed depends on whether they are general or particular for each axis.

- If it affects the axes, the parameter number (PAR??) appears on each axis display and the corresponding axis key must be pressed to modify it.



- If it is a general parameter and there are more than one axis, the X display will show the parameter number and the Y its current value. If there is only one axis, its number will appear on the X display and, after pressing this key, its value.

There are several kinds of parameters depending on how to set them:

1

to

8



- With binary values, it only takes values of 0 or 1 for each digit. The value is changed by pressing the key with the relevant digit between [1] and [8]. Where [1] corresponds to the rightmost digit of the display and [8] to the leftmost digit.

- Numeric values, usually with the corresponding axis resolution, they are entered as regular coordinate preset.





- Options; the value is changed by pressing this key which will make the various options appear in a cyclic way.

To get into parameter editing

  The dro displays must be on, reading mode and press the following keys:
CODE: 060496 The X axis display shows the word " **COdE** ". **060496**

The displays of the DRO show **PAR00**.

   Once in regular display mode, parameter **PAR05** (scaling factor) may also be recalled by pressing this keystroke sequence, so the work mode may be changed without having to go through all the previous steps.

Note: Like PAR05, parameter PAR53 is directly accessible.

To enter a parameter

   • Select axis.

[Value]  • Press this key to save the displayed value.

 • Press this key to cancel the modification.

Move through parameters



 Press the [ENTER] key to go on to the next parameter or ---



 Press this key to return to the previous one.

To quit the parameter editing mode:





 Press this key.

To go to a particular parameter:

 **PAR Nr**  To go directly to a particular parameter without going through the previous ones, (once in parameter editing mode) press this key sequence.

   Then, select the axis affecting this parameter.

To recover the factory set default values for the installation parameters:

    Once in parameter editing mode, **displaying PAR00** on all the displays, press this keystroke sequence. The dots of the first axis will light up.

3.7 Parameters to configure axis position reading and display.

The digits of digital parameters refer to the digits on the axis displays so digit "1" (that can be changed with the [1] key) corresponds to the rightmost digit and "8" to the leftmost digit.

X X X X X X X X <-- binary code

8 7 6 5 4 3 2 1 <-- keys

PARAMETER	FUNCTION
PAR00	Feedback configuration, different per axis, binary type. This parameter sets the specific characteristics of the feedback device (rotary or linear encoder) used to read the axis position.
Digit	
8, 7, 6	Not being used at this time (they must be set to "0")
5	Feedback resolution units: Linear axis: 0 = mm, 1 = leadscrew pitch in inches. Rotary axis: 0 = degrees, 1 = seconds.
	Note: These units refer to feedback pulses not to the position display.
4	Type of axis: 0 = Linear, 1 = Rotary
3	Not being used at this time
2	Not being used; it must be set to "0".
1	Counting direction (0 = normal, 1 = reverse) If an axis count increases or decreases in the opposite direction to the one desired, change the value of this digit.
PAR01	Feedback resolution. Independent for each axis. Possible values: Linear axis: From 0.0001 mm up to 1.0000 mm (0.000005" to 0.03937") Rotary axis: From 0.0001° to 1.0000° (from 1 to 999 seconds). Factory setting: 0.0050 mm (5 µm).
	Formula to calculate encoder resolution:
	$R = \frac{360}{p \times TTLfactor \times Sfactor} = \frac{360}{p \times PAR02 \times PAR03}$
	Where:
	R = Resolution in degrees
	p = Pulses per turn of the encoder
	TTLfactor = Multiplying factor for TTL signal
	Sfactor = Multiplying factor for sinusoidal signal

PAR02**TTL multiplying factor (subdivision).** Independent for each axis.**Options:** x4, x2, x1 and x0.5.

The factory setting is x4 and it is the one used for FAGOR linear encoders.

When using rotary encoders on linear axes, it should be calculating according to the number of pulses of the encoder, leadscrew pitch and the desired resolution as per the formula:

$$p = \frac{P}{R \times F}$$

Where:

p = Pulses per turn of the encoder**P** = Leadscrew pitch in mm/turn**R** = Resolution in mm/pulse**F** = Multiplying factor to be applied.**PAR03****External multiplying factor** when using distance-coded reference marks or TTL signals.

Independent for each axis. It is not required when using absolute feedback.

**Options:** 1, 5, 10, 20, 25, 50.**Factory setting: 1****Feedback parameters**

Signal	Model	PAR00 XXXXXXXX	PAR01 mm	PAR02	PAR03	PAR14
TTL	MT / MKT CT FT	0000000X	0.005	4	X	00X0XX00
TTL dif.	MTD MX / MKX CX SX GX FX LX		0.001			
	MOX COX SOX GOX				5	00X00010
	FOX				25	00X01010
	LOX				10	00X00110

Note: In the table, X means that the bit is irrelevant.

PAR04 **Axis display.** Independent for each axis.

Digit

8, 7, 6, 5, 4 Not being used at this time (they must be set to "0"),

3 **Turn the axis display off.** 0 = No, 1 = Yes.

2 **Axis display toggle radius/diameter**

0 = no toggle, 1 = toggle

1 **Axis display.** 0 = radius, 1 = diameters.

Note: When a rotary axis, the setting of this parameter will be ignored.

PAR05 **Shrink or scaling factor** independent for each axis.

Numeric value within ± 9.999 .

A "0" value means that no factor is to be applied. It is not applied when reading with respect to machine reference zero (its LED on) or onto the tool when applying tool compensation (TOOL led on).

The factory setting is "0".

Note: When a rotary axis, the setting of this parameter will be ignored.

PAR07 **Combine the reading of an axis.** Independent for each axis.



It indicates the number of the axis to be added; "0" means none, 1 = X axis, 2=Y, 3=Z. With the negative sign, the other axis' count will be subtracted.

Factory setting: "0".

The axis being combined must have the same resolution as the one combined with (PAR01, PAR02, PAR03).

Possible values: -2 to 2. (20i-M), -3 to 3 (30i-M)

Note: When a rotary axis, the setting of this parameter will be ignored.

PAR08 **Use of alarms.**

Indicates whether the alarms for feedrate, travel limits and feedback will be activated or not.

Digit

8, 7, 6, 5 Not being used at this time (they must be set to "0")

4 **Active value of the feedback alarm.** (0=low, 1=high)

3 **Detect feedback alarm provided by the linear encoder.** 0 = No, 1 = Yes.

2 **Detect travel limits (PAR12 and PAR13).**When this alarm is activated, the axis value blinks.

The blinking axis error is cleared by returning the axis within its limits

-
- 1 Detect feedback speed alarm when exceeding 200Khz (60m/min with a resolution of 1µm). Not applicable to a rotary axis.
Possible values: 0 (alarms off) and "1" (alarms on).
Factory-set (default) values: 0
Feedback and feedrate alarms are shown with (.) at the display.



The errors may be cleared by pressing this key.

PAR09 **Linear compensation of a machine axis.** Independent for each linear axis.
Numeric value within ±99.999 millimeters per meter.
Factory setting: 0.

Notes: Even when selecting the display in inches, this value MUST ALWAYS BE IN MILLIMETERS.

1 inch = 25.4 mm

When a rotary axis, the setting of this parameter will be ignored.

PAR10 **Offset of the reference point** with respect to the reference zero of the scale, independent for each axis.

Usually, the machine reference zero (reference mark of the linear encoder) does not coincide with the absolute zero to be used.

Therefore, when using standard I/O's, this parameter must be assigned the value of the distance from the machine zero point to the feedback reference point.

Numeric value in resolution units for each axis.

Factory setting: 0.

This value will be in mm or inches depending on whether the INCH LED is off or on.

PAR11 **Personalize.**

Digit

- 8 Not being used. Must be set to "0".
- 7 Operate always in mm.
- 6 Operate always in inches.
- 5 Do not display "Fagor DRO" on power-up.
- 4 If =0, normal zero setting and coordinate presetting (factory set)
If =1, quick zeroing of the position value displayed on each axis.
- 3 If =1, allow the selection of the work plane for linear or bolt-hole drilling.
- 2 Not being used; it must be set to "0".

1  The key affects one axis (= 0) or both (= 1).

If it affects each axis independently, after pressing this key, one must press the axis key.

It may toggle from absolute reading mode to incremental. This parameter determines whether this toggle affects one axis or both (20i-M, 30i-M).

Factory setting: "1".

PAR12, PAR13

Travel limit.

To set the negative axis travel limit.

Both parameters admit any value.

This value will be in mm or inches depending on whether the INCH LED is off or on.

If PAR08 bit 2 = 1, when the axis exceeds the travel distance between both parameters, the relevant display starts blinking until it is positioned within these limits.

PAR14

Binary type home search setting.

Digit

- 8, 7 Not being used at this time (they must be set to "0")
- 6 If =1, it indicates **mandatory home search on power-up**.
- 5 **Direction of the distance-coded lo** (0 = Increasing , 1 = Decreasing).
- 4 1 = **Pitch of the distance-coded lo 100 mm, 0 = 20 mm**
- 3 1 = **Pitch of the distance-coded lo: 40 mm. 0 = 20 mm**
- 2 **Type of lo of the linear encoder.** (0 = fixed, 1 = distance-coded).
- 1 If =1, **Linear encoder without IO**. To carry out a home search when the feedback device does not have a reference mark "lo", this parameter must be set to "1".
- Factory setting: "0".**

PAR15**Multi-point leadscrew error compensation.**

Important: Before capturing data for an accuracy graph, the axis (axes) must be **homed (referenced)** because the compensation will not be applied until they are homed. To use this compensation, it is recommended to set **PAR 14** so as to force a mandatory home search on power-up.

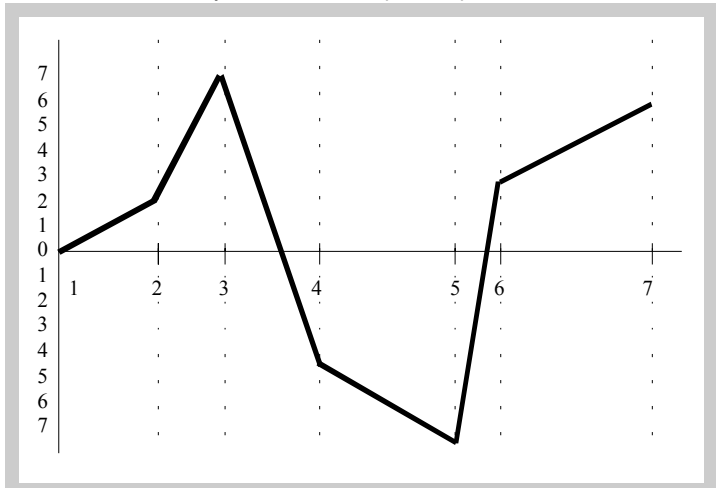

The compensation point must have at least one point with no error

Multi-point leadscrew error compensation table (in mm)

Point Nr.	Position	Error to be compensated
1	0	0
2	200.000	0.002
3	275.250	0.007
4	427.345	-0.005
5	700.500	-0.007
6	760.000	0.003
7	1015.000	0.006







(error 0).



Select the desired axis and enter the number of points to be used for the axis, up to 40; zero means that there is no compensation table for the axis.

POS 1
ERROR 1

Where "POS 1" is the point number to enter and "ERROR 1" the amount of error to be compensated.

-  Pressing [ENTER] displays the position value (X axis display) and the amount of error to be compensated (Y axis display).
-  [Pos Nr]  **Error to be compensated = Master's actual position - displayed position**
-  [Error]  It goes on to edit the next point.
-  Press this key to exit.

PAR20 It sets the configuration of the axes.

Digit

- 8** Turn the feedback off after 2 minutes in "DISPLAY OFF" mode.
- 7** The displays turn off if none of the axis has moved in 30 minutes. Pressing any key or moving any of the axes turns the displays back on.
- 3, 2, 1** Apply hysteresis onto the 3rd, 2nd and 1st axis respectively

PAR25 **Hysteresis distance** desired to avoid the flickering of the displayed position

PAR53 **Select the number of decimals to be displayed.**

Possible values:0.0 to 6.6 .



The first digit corresponds to the number of decimals to be displayed in mm and the second digit to the number of decimals in inches.

When selecting a "0" value or a value greater than the number of decimals of **PAR01** it will display the factory set number of decimals.

Note: It has no effect on rotary axes.

PAR65 It enables various functions of the dro.

Digit

- 8** 1= To enter the tool length.
- 7** 1= To enter the tool diameter.
- 6** 1= To compensate for tool radius.
- 5** 1= To directly access parameter PAR05.
- 4** Not being used at this time. They must be set to zero.
- 3** 1 = Enables the buzzer. It beeps when pressing any key.
- 2**  Enables this key (linear and bolt-hole drilling, etc.)
- 1**  It enables this key.

4.1 UL seal

See "UL seal" page 23.

4.2 CE seal



Warning

Before starting up the DRO, carefully read the instructions of Chapter 2 in the Installation Manual.

The DRO must not be powered-on until verifying that the machine complies with the "89/392/CEE" Directive.

4.2.1 Declaration of conformity

Manufacturer: **Fagor Automation, S. Coop.**

Barrio de San Andrés 19, C.P. 20500, Mondragón -Guipúzcoa (ESPAÑA)

We hereby declare, under our responsibility that the product:

Fagor Digital Readout:

20i-M, 20i-M B, 30i-M, 30i-M B

meets the following directives:

SAFETY:

EN 60204-1 Machine safety. Electrical equipment of the machines

ELECTROMAGNETIC COMPATIBILITY:

EN 61000-6-4 Emission
EN 55011 Radiated. Class A, Group 1.
EN 55011 Conducted. Class A, Group 1.
EN 61000-3-2 Harmonics
EN 61000-3-3 Flickers.
EN 61000-6-2 Immunity
EN 61000-4-2 Electrostatic discharges.
EN 61000-4-3 Radiofrequency Radiated Electromagnetic Fields.
EN 61000-4-4 Bursts and fast transients.
EN 61000-4-5 Shockwaves
EN 61000-4-6 Conducted disturbance induced by radio frequency fields.
EN 61000-4-8 Magnetic fields at mains frequency
EN 61000-4-11 Voltage fluctuations and Outages.
ENV 50204 Electromagnetic fields radiated by wireless telephones.

As instructed by the European Community Directives on Low Voltage: 73/23/EEC, (and the 93/68/EEC amendment) on Machine Safety 89/392/EEC and 89/336/EEC on Electromagnetic Compatibility.

In Mondragón, April 1st, 2005

Fagor Automation, S. Coop. Ltda.
Director Gerente

Fdo.: Julen Busturia

4.2.2 Safety conditions

Read the following safety measures in order to prevent damage to personnel, to this product and to those products connected to it.

Fagor Automation shall not be held responsible for any physical or material damage derived from the violation of these basic safety regulations.

Do not manipulate the inside of the unit



Only personnel authorized by Fagor Automation may manipulate the inside of this unit.

Do not handle the connectors while the unit is under power.



Before handling the connectors (mains, feedback, etc.) make sure that the unit is not under power.

Use proper Mains AC power cables.

To avoid risks, use only the Mains AC cables recommended for this unit.

Avoid electrical overloads

In order to avoid electrical discharges and fire hazards, do not apply electrical voltage outside the range indicated in chapter 2 of this manual

Ground connection

In order to avoid electrical discharges, connect the ground terminals of all the modules to the main ground terminal. Before connecting the inputs and outputs of this unit, make sure that all the grounding connections are properly made.

Before powering the unit up, make sure that it is connected to ground

In order to avoid electrical discharges, make sure that all the grounding connections are properly made.

Ambient conditions

Respect the limits for temperature and relative humidity indicated in chapter "General technical characteristics" page 24

Do not work in explosive environments

In order to avoid risks, damage, do not work in explosive environments.

Work environment

This unit is ready to be used in Industrial Environments complying with the directives and regulations effective in the European Community.

It is recommended to mount the DRO vertically,

so its power switch of the back panel is at a distance between 0.7 m (27.5 inches) and 1.7 m (5.6 ft) off the floor and away from coolants, chemical products, blows etc that could damage it. Keep it away from direct sunlight, extremely hot air, high voltage and high current sources as well as from relays, or high electromagnetic fields (about 0.5 m or 20 inches).

This unit complies with the European directives on electromagnetic compatibility. Nevertheless, it is recommended to keep it away from sources of electromagnetic disturbance such as.

- Powerful loads connected to the same AC power line as this equipment.
- Nearby portable transmitters (Radio-telephones, Ham radio transmitters).
- Nearby radio / TC transmitters.
- Nearby arc welding machines.
- Nearby High Voltage power lines.
- Disturbance generating elements of the machine.
- Etc.

Safety symbols

Symbols which may appear on the manual



WARNING symbol.

It has an associated text indicating those actions or operations may hurt people or damage products.

Symbols that may be carried on the product



WARNING symbol.

It has an associated text indicating those actions or operations may hurt people or damage products.



“Electrical shock” symbol.

It indicates that point may be under electrical voltage.



“Ground Protection” symbol.

It indicates that point must be connected to the main ground point of the machine as protection for people and units.

4.2.3 Warranty terms

WARRANTY

All products manufactured or marketed by Fagor Automation has a warranty period of 12 months from the day they are shipped out of our warehouses.

The mentioned warranty covers repair material and labor costs, at FAGOR facilities, incurred in the repair of the products.

Within the warranty period, Fagor will repair or replace the products verified as being defective.

FAGOR is committed to repairing or replacing its products from the time when the first such product was launched up to 8 years after such product has disappeared from the product catalog.

It is entirely up to FAGOR to determine whether a repair is to be considered under warranty.

EXCLUDING CLAUSES

The repair will take place at our facilities. Therefore, all shipping expenses as well as travelling expenses incurred by technical personnel are NOT under warranty even when the unit is under warranty.

This warranty will be applied so long as the equipment has been installed according to the instructions, it has not been mistreated or damaged by accident or negligence and has been manipulated by personnel authorized by FAGOR.

If once the service call or repair has been completed, the cause of the failure is not to be blamed the FAGOR product, the customer must cover all generated expenses according to current fees.

No other implicit or explicit warranty is covered and FAGOR AUTOMATION shall not be held responsible, under any circumstances, of the damage which could be originated.

SERVICE CONTRACTS

Service and Maintenance Contracts are available for the customer within the warranty period as well as outside of it.

4.2.4 Material returning terms

When returning the DRO, pack it in its original package and with its original packaging material. If not available, pack it as follows:

Get a cardboard box whose three inside dimensions are at least 15 cm (6 inches) larger than those of the unit. The cardboard being used to make the box must have a resistance of 170 Kg (375 lb.).

When sending it to a Fagor Automation office for repair, attach a label indicating the owner of the unit, person to contact, type of unit, serial number, symptom and a brief description of the problem.

Wrap the unit in a polyethylene roll or similar material to protect it.

Pad the unit inside the cardboard box with polyurethane foam on all sides.

Seal the cardboard box with packing tape or industrial staples.

4.3 Error codes

Error codes

Error	Description
FAGOR dro	Power outage or turned off with main switch after saving the data.
Error 02	The unit has been turned off without previously pressing [ON/OFF]. It only loses feedback reading (it resets it to zero and the status of the operating modes, inch, abs, radius, etc.).
Error 04	Wrong parameter data
Error 05	Wrong internal configuration
Error 06	Errors in data backup memory (Service Dept.)
Error 07	Emergency input active. Press [CLEAR] or cancel the emergency signal.
Error 08	Wrong software memory or the software has been changed.
Error 09	Errors in work memory (Service Dept.)
Error 12	Error while searching a distance-coded reference mark (lo).
Error 31	Internal malfunction (Service Dept.).
Error 32	Internal malfunction (Service Dept.).
Error 99	Internal malfunction (Service Dept.).
.....	Feedback alarm coming from the feedback device (linear or rotary encoder).
1. 4. 3. 6. 5. 7. 2. 5	Feedback speed too high.
EEEEEEEE	Maximum position reading or speed exceeded when searching home.

If any message other than the first two from the table were to come up, the equipment should be switched off and on again until one of the first two are seen.



After pressing this key to access the counting mode, check the parameters.

If any of the errors shown as (Service Department) are often repeated, ask Fagor Automation's Customer Services Department about this.

If the display of any axis shows all its dots; for example: 1.4.3.6.5.7.2.5. It means that the axis has been moved too fast (>200 KHz or 60 m/min with 1 µm resolution). This error will be displayed if the alarm activation parameter for the axis PAR08(1) = 1



To clear the display, press this key.

If the axis value is flashing, this means that one of the travel limits established by machine parameter has been exceeded. This error will be displayed if the alarm activation parameter for the axis PAR08(2) = 1

If the DRO does not come on or goes out while running, check that the voltage and ground outlets are as they should be. If there are OK, disconnect the feedback connectors one by one. If the dro comes on, it means a feedback failure. If the fault persists get in touch with Fagor Automation's Customer Services Department about it.

4.4 Maintenance

Cleaning: An accumulation of dirt in the equipment can act as a screen preventing proper dissipation of the heat generated by the internal electronic circuits with the consequent danger of overheating and DRO fault.

Accumulated dirt can also, in some cases, provide a conductive path for electricity which could give rise to faults in the internal circuits of the equipment, especially in high humidity conditions.

To clean the equipment nonabrasive dish-washing detergents are recommended (in liquid, never powder form) or 75% isotropic alcohol with a clean cloth. DO NOT USE aggressive solvents, (benzol, acetones, etc.) which could damage the materials the equipment is made with.

Do not use high pressure compressed air to clean the item as this could give rise to an accumulation of charges which in turn lead to electrostatic discharges.

The plastics used in the front panel of the DRO stand up to:

- Grease and mineral oils.
- Alkalis and bleaches.
- Dissolved Detergents.
- Alcohol

Avoid the effect of solvents such as Chlorohydrocarbons, Benzol, Esters and Ethers because these could damage the plastics with which the front of the equipment is made.

Preventive Inspection

If the DRO does not come on press the rear switch for starting, make sure it is properly connected and being supplied with the proper mains voltage.

FAGOR AUTOMATION S. COOP.

B^a San Andrés N^o 19

Apdo de correos 144

20500 Arrasate/Mondragón

- Spain -

Web: www.fagorautomation.com

Email: info@fagorautomation.es

Tel.: (34) 943 719200

Fax: (34) 943 791712



Fagor Automation S. Coop.